

MAGNAVOX

OWNER'S MANUAL

**WINDOW/WALL-TYPE
ROOM AIR CONDITIONER**

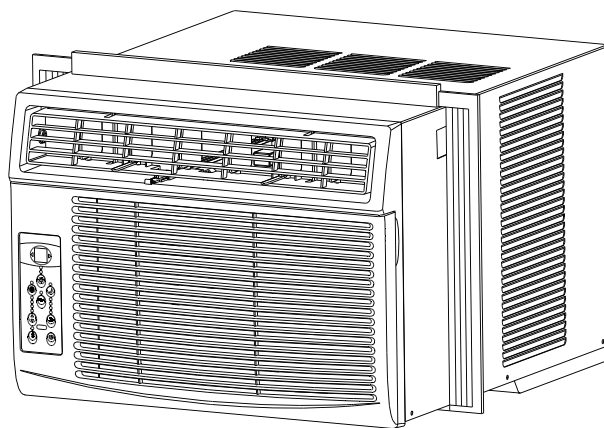

MODEL: W-08CR
W-10CR
W-12CR

For any service needs, call 1-855-368-8606

Before using this product,
please read the instructions
carefully and keep for future reference.

CONTENTS

1. SAFETY PRECAUTIONS	2
2. IMPORTANT SAFETY INSTRUCTIONS	4
3. AIR CONDITIONER FEATURES	5
4. INSTALLATION INSTRUCTIONS	10
5. CLEANING AND MAINTENANCE	14
6. TROUBLESHOOTING TIPS	15
7. NORMAL OPERATING SOUNDS	17

Read This Manual

Inside you will find many helpful tips on how to use and maintain your air conditioner properly. Just a little preventive care on your part can save you a great deal of time and money over the life of your air conditioner. You'll find many answers to common problems in the Troubleshooting Tips section.



CAUTION

- This appliance is not intended for use by children or persons with reduced physical, sensory or mental capabilities, unless they are supervised by a responsible adult or considered capable enough to operate the appliance safely.
- Children should be supervised to ensure that they do not play with the appliance.
- If the supply cord is damaged, it must be replaced by the manufacturer, its service agent or similarly qualified persons in order to avoid a hazard.
- The appliance should be installed in accordance with national wiring regulations.
- Do not operate your air conditioner in a wet room such as a bathroom or laundry room.
- The appliance with electric heater should not be operated near any combustible materials.
- Contact the authorised service technician for any repairs, maintenance, or have problems installing the unit.



*NOTE: All the illustrations in this manual are for explanation purposes only.
Your air conditioner may appear to be slightly different.*

Safety Precautions

To prevent injury to the user or other people and property damage, the following instructions must be followed. Incorrect operation may cause harm or damage. The seriousness is classified by the warning symbols below.

 WARNING	This symbol indicates the possibility of death or serious injury.
 CAUTION	This symbol indicates the possibility of injury or damage to property.

■ Definition of symbols used in this manual are as shown below.

	Never do this.
	Always do this.

WARNING

Ⓢ Plug in power plug properly.

- Otherwise, this may cause electric shock or fire due to excess heat generation.

Ⓢ Do not operate or stop the unit by inserting or pulling out the power plug.

- This may cause electric shock or fire due to heat generation.

Ⓢ Do not damage or use an unspecified power cord.

- This may cause electric shock or fire.
- If the power cord is damaged, it must be replaced by the manufacturer or an authorised service centre or a similarly qualified person in order to avoid a hazard.

Ⓢ Do not modify power cord length or share the outlet with other appliances.

- This may cause electric shock or fire due to heat generation.

Ⓢ Do not operate with wet hands or in damp environment.

- This may cause electric shock.

Ⓢ Do not point airflow at room occupants directly.

- This could be harmful to your health.

Ⓢ Always ensure effective grounding.

- Incorrect grounding may cause electric shock.

Ⓢ Do not allow water to run into electric parts.

- This may cause failure of machine or electric shock.

Ⓢ Always install circuit breaker and a dedicated power circuit.

- Incorrect installation may cause fire and electric shock.

Ⓢ Unplug the unit if strange sounds, smell, or smoke comes from it.

- This may cause fire and electric shock.

Ⓢ Do not use the socket if it is loose or damaged.

- This may cause fire and electric shock.

Ⓢ Do not open the unit during operation.

- This may cause electric shock.

Ⓢ Keep firearms away.

- This may cause fire.

Ⓢ Do not use the power cord close to heating appliances.

- This may cause fire and electric shock.

Ⓢ Do not use the power cord near flammable gas or combustibles, such as gasoline, benzene, thinner, etc.

- This may cause an explosion or fire.

Ⓢ Ventilate room before operating air conditioner if there is a gas leakage from another appliance.

- This may cause explosion, fire and, burns.

Ⓢ Do not disassemble or modify unit.

- This may cause failure and electric shock.



CAUTION

⊖ When the air filter is removed do not touch the exposed metal parts.

- This may cause an injury.

⊖ Do not clean the air conditioner with water.

- Water may enter the unit and degrade the insulation and cause electric shock.

⊖ Ventilate the room well when a stove is being used in the same room.

- An oxygen shortage may occur.

⊖ When the unit is cleaned, switch off, and turn off the circuit breaker.

- Do not clean unit when power is on as it may cause fire and electric shock, or cause an injury.

⊖ Do not put a pet or house plant where it will be exposed to direct air flow.

- This could injure the pet or plant.

⊖ Do not use for special purposes.

- Do not use this air conditioner to preserve precision devices, food, pets, plants, and art objects. It may cause deterioration of quality, etc.

⊖ Stop operation and close the window in storm or hurricane.

- Operation with windows opened may cause water damage to indoor property

⊖ Hold the plug by the head of the power plug when taking it out.

- This may cause electric shock and damage.

⊖ Turn off the main power switch when not using the unit for a long time.

- This may cause failure of product or fire.

⊖ Do not place obstacles around air-inlets or inside of air-outlet.

- This may cause failure of appliance or accident.

⊖ Ensure that the installation bracket of the outdoor appliance is not damaged due to prolonged exposure.

- If bracket is damaged, there is danger of damage due to falling unit.

⊖ Always insert the filters securely. Clean filter once every two weeks.

- Operation without filters may cause failure.

⊖ Do not use strong detergent such as wax or thinner, only use a soft cloth.

- Appearance may be deteriorated due to change of product color or weaken the surface of the unit.

⊖ Do not place heavy object on the power cord and ensure that the cord is not compressed.

- This may cause fire or electric shock.

⊖ Do not drink water drained from air conditioner.

- The water may contain contaminants and could make you sick.

⊖ Use caution when unpacking and installing. Sharp edges could cause injury.

⊖ If water enters the unit, turn the unit off at the power outlet and switch off the circuit breaker. Isolate supply by taking the power-plug out and contact a qualified service technician.

IMPORTANT SAFETY INSTRUCTIONS

NOTE For some models, the power cord for this air conditioner contains a current detection device designed to reduce the risk of fire. Please refer to the section 'Operation of Current Detection Device' for details. In the event that the power cord is damaged, it cannot be repaired, it must be replaced with a cord from the Product Manufacturer.

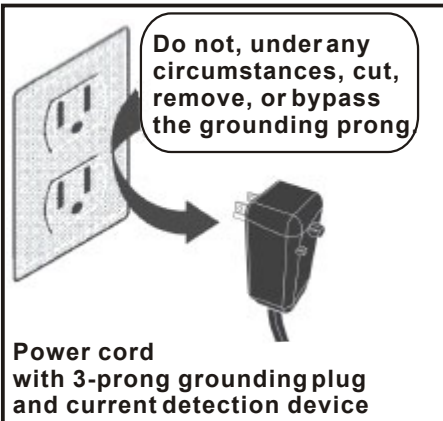

⚠ WARNING For your safety

- Do not store or use gasoline or other flammable vapors and liquids in the vicinity of this or any other appliance.
- To avoid fire hazard or electric shock, do not use an extension cord or an adaptor plug. Do not remove any prong from the power cord.

⚠ WARNING Electrical Information

- Be sure the power requirement is adequate for the model you have chosen. This information can be found on the serial plate, which is located on the side of the cabinet and behind the grille.
 - Be sure the air conditioner is properly grounded. To minimize shock and fire hazards, proper grounding is important. The power cord is equipped with a three-prong grounding plug for protection against shock hazards.
 - Your air conditioner must be used in a properly grounded wall receptacle. If the wall receptacle you intend to use is not adequately grounded or protected by a time delay fuse or circuit breaker, have a qualified electrician install the proper receptacle.
 - Ensure the receptacle is accessible after the unit installation.
 - Do not run air conditioner without side protective cover in place. This could result in mechanical damage within the air conditioner.
- Do not use an extension cord or an adapter plug with unit.**

Operation of Current Detection Device

(Applicable only to certain units with current detection device)

The power cord contains a current detection function that senses damage to the power cord. To test your power cord, do the following:

1. Plug in the Air Conditioner.
2. The power supply cord will have TWO buttons on the plug head. Press the TEST button, you will notice a click as the RESET button pops out.
3. Press the RESET button, again you will notice a click as the button engages.
4. The power supply cord is now supplying electricity to the unit. (On some products this is also indicated by a light on the plug head.)

NOTES:

- Do not use this device to turn the unit on or off.
- Always make sure the RESET BUTTON IS PUSHED IN for correct operation.
- The power cord must be replaced if it fails reset when either the TEST button is pushed, or it cannot
- If power cord is damaged, it cannot be repaired. It MUST be replaced by one obtained from the product manufacturer.

NOTE: This air conditioner is designed to be operated under the following conditions:

Cooling operation	Outdoor temp:	18-43°C/64-109°F (18-52°C/64-125°F for special tropical models)
	Indoor temp:	17-32°C/62-90°F
Heating operation	Outdoor temp:	-5-24°C/23-76°F
	Indoor temp:	0-27°C/32-80°F

Note: Performance may be reduced outside of these operating temperature ranges.

AIR CONDITIONER FEATURES

ELECTRONIC CONTROL OPERATING INSTRUCTIONS

Before you begin, familiarize yourself with the control panel on the unit and the remote control as shown below and refer to the symbols for the functions you desire. **The unit can be controlled by either the unit controls or with the remote control.**

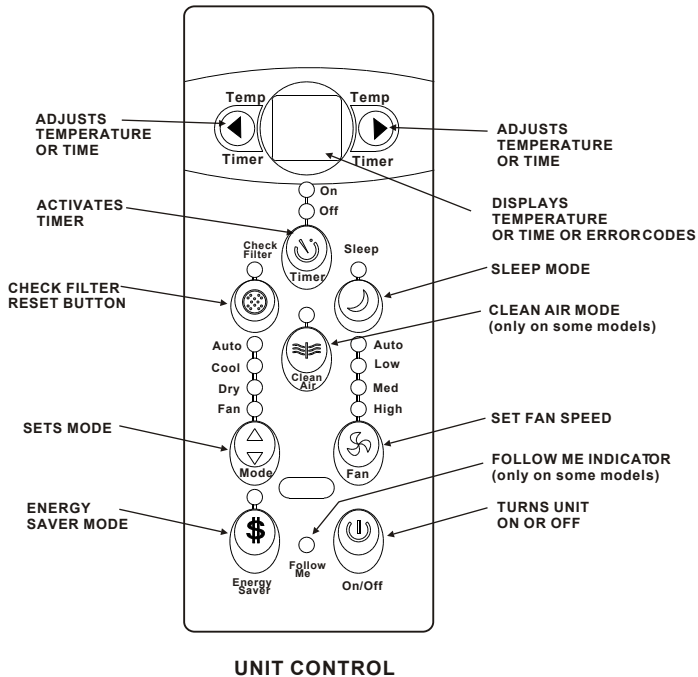

NOTE: The following instructions represent the control panel on the unit, the same instructions can be used for the remote control.

TO TURN UNIT ON:

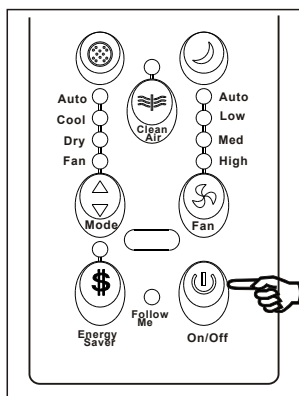

NOTE: (ON/OFF button)

The unit will initiate automatically the Energy Saver function under COOL, DRY, AUTO (only Auto-Cooling and Auto-Fan) modes.

DO THIS:
Press the ON/OFF button.

AIR CONDITIONER FEATURES(CONTINUED)

TO CHANGE TEMPERATURE SETTING:

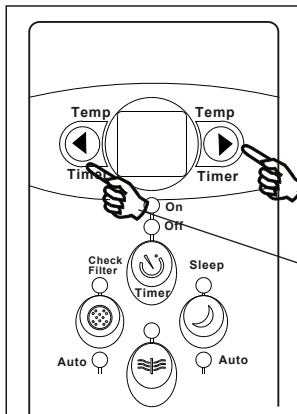

DO THIS:
 Press to raise
 Press to lower

NOTE:(LEFT/RIGHT button)

Press or hold either LEFT (<) or RIGHT(>) button until the desired temperature is shown on the display. This temperature will be automatically maintained anywhere between 62°F(17°C) and 86°F(30°C). If you want the display to read the actual room temperature, see “To Operate on Fan Only” section.

TO ADJUST FAN SPEEDS:

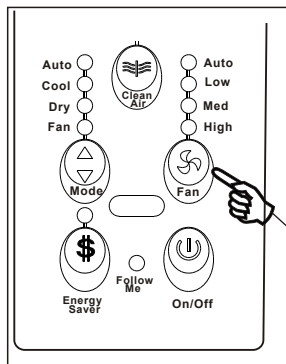

DO THIS:
 Press to select appropriate fan speed

NOTE: (FAN button)

Used to select the Fan Speed in four steps- AUTO, LOW, MED or HIGH. Each time the button is pressed, the fan speed mode is shifted. For some models, the fan speed can not be adjusted in HEAT mode. On DRY mode, the fan speed is set to LOW automatically.

TO SELECT THE OPERATING MODE:

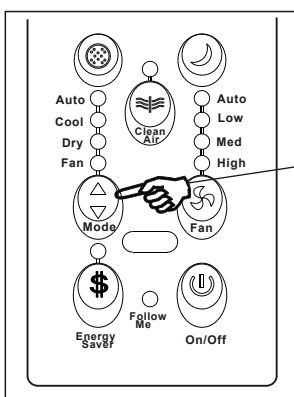

DO THIS:
 Press the MODE button.

NOTE: (MODE button)

- To select mode, press the Mode button. Each time you press the button, the mode will change based on the sequence from AUTO, COOL, DRY and FAN. The indicator light will show the mode selected.

To operate on Auto feature:

- When you set the air conditioner to AUTO mode, it will automatically select cooling, heating (not available in Cooling-only models), or fan only operation depending on the temperature selected and the current room temperature.
- The air conditioner will adjust room temperature automatically to the approximate temperature point set.
- In this mode, the fan speed cannot be adjusted, as the fan speed is being controlled automatically.

To operate on Fan Only:

- Use this function only when cooling is not desired, such as for room air circulation or to exhaust stale air(only on some models). (Remember to open the vent during this function, but keep it closed during cooling for maximum cooling efficiency.) You can choose any fan speed you prefer.

AIR CONDITIONER FEATURES(CONTINUED)

TO USE THE ENERGY SAVER FEATURE:

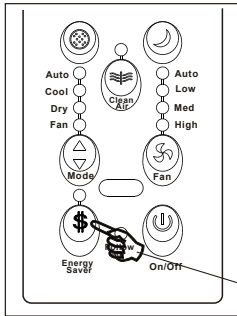

DO THIS:
Press the button

SLEEP FEATURE:

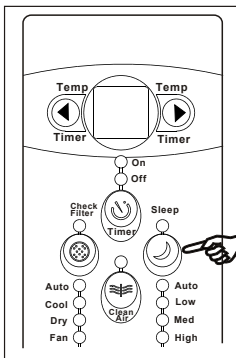

DO THIS:
Press SLEEP button

- During this function, the display will show the actual room temperature, not the set temperature as in the cooling mode.
- In Fan only mode, the temperature is not adjusted.

To operate on DRY mode:

- In this mode, the air conditioner will generally operate as a dehumidifier. In a closed or sealed space, some degree of cooling will continue.

NOTE:(ENERGY SAVER button)

Press Energy Saver button to initiate this function. This function is available on COOL mode. The fan will continue to run for 3 minutes after the compressor shuts off. The fan then cycles on for 2 minutes intervals until the room temperature is above the set temperature, at which time the compressor turns back on and cooling starts.

NOTE: (SLEEP button)

In this mode the selected temperature will increase by one degree, 30 minutes after the mode is selected. The temperature will then increase by another one degree after an additional 30 minutes. This new temperature will be maintained for 6 hours before it returns to the originally selected temperature. This ends the Sleep mode and the unit will continue to operate as originally programmed. The Sleep mode program can be cancelled at any time during operation by pressing the SLEEP button again.

AIR CONDITIONER FEATURES(CONTINUED)

TIMER: AUTO START/ STOP FEATURE:

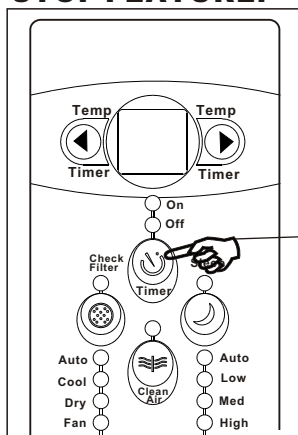

DO THIS:
Press TIMER button

NOTE:(TIMER button)

- Press the TIMER button, and the TIMER ON indicator light will illuminate to indicate that the AUTO START program is initiated.
- Press the TIMER button again to show the TIMER OFF indicator light which indicates that the AUTO STOP program is initiated.
- Press or hold the UP or DOWN button to change the timer duration by 30 minute increments, up to 10 hours then at 1 hour increments up to 24 hours. The control will count down the time remaining until start. The selected time will register in 5 seconds, and the system will automatically revert back to display the previous temperature setting or room temperature when the unit is on.(when the unit is off, there is no display.)
- Turning the unit ON or OFF at any time or adjusting the timer setting to 0.0 will cancel the Auto START/STOP program.

CHECK FILTER FEATURE:

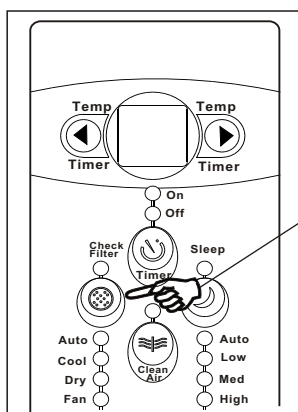

DO THIS:
Press CHECK FILTER button

NOTE:(CHECK FILTER button)

This feature is a reminder to clean the Air Filter for more efficient operation. The LED (light) will illuminate after 250 hours of operation. To reset after cleaning the filter, press the Check Filter button and the light will go off.

CLEAN AIR FEATURE: (only on some models)

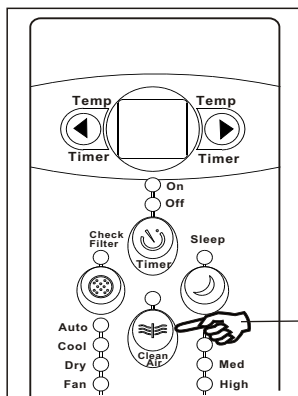

DO THIS:
Press CLEAN AIR button

NOTE:(CLEAN AIR button)

Press the CLEAN AIR button, the ion generator is energized and will help to remove pollen and impurities from the air, and trap them in the filter.

DISPLAYS:

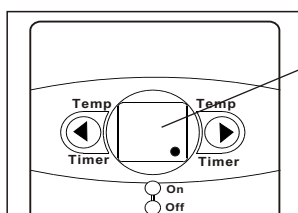

Displays

DISPLAYS:

Shows the set temperature in " °C" or " °F" and the AUTO-TIMER settings. While in Fan only mode, it shows the room temperature.

Error codes:

- AS**-Room temperature sensor error.
 - Unplug the unit and plug it back in. If error repeats, call for service.
 - NOTE:In Fan only mode, it will display "LO" or "HI".
- -Evaporator temperature sensor error.
 - Unplug the unit and plug it back in. If error repeats, call for service.
 - NOTE: " • " is displayed as shown in the left diagram.
- HS**- Electric heating sensor error.
 - Unplug the unit and plug it back in. If error repeats, call for service.

AIR CONDITIONER FEATURES(CONTINUED)

FOLLOW ME FEATURE: (only on some models)

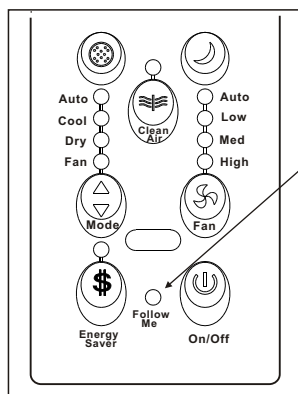

NOTE:

This feature can only be activated from the remote control. The remote control serves as a remote thermostat allowing for the precise temperature control at its location.

To activate the Follow Me feature, point the remote control towards the unit and press the Follow Me button. The remote display shows the actual temperature at its location. The remote control will send this signal to the air conditioner every 3 minutes interval until press the Follow Me button again. If the unit does not receive the Follow Me signal during any 7 minutes interval, the unit will keep to indicate the Follow Me mode has ended.

ADDITIONAL THINGS YOU SHOULD KNOW

Now that you have mastered the operating procedure, here are more features in your control that you should become familiar with.

- The Cool circuit has an automatic 3 minute time delayed start if the unit is turned off and on too abruptly. This prevents overheating of the compressor and possible circuit breaker tripping. The fan will continue to run during this time.
- The unit can show the temperature in Fahrenheit or Celsius.
To convert from one to the other, press and hold the LEFT and RIGHT TEMP/TIMER buttons at the same time, for 3 seconds.

Fresh Air Vent Control(on 10000~12000Btu/h models):

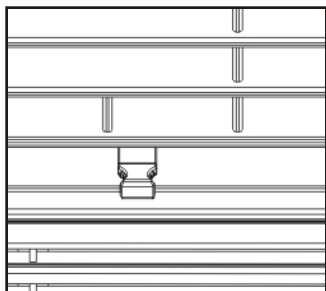

Fig. A (VENT CLOSED)

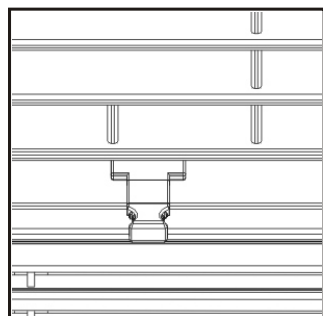

Fig. B (VENT OPEN)

- The Fresh Air Vent allows the air conditioner to:
1. Recirculate inside air- Vent Closed (See Fig.A)
 2. Draw fresh air into the room- Vent Open (see Fig.B)
 3. Exchange air from the room and draws fresh air into the room- Vent and Exhaust Open (see Fig.C)

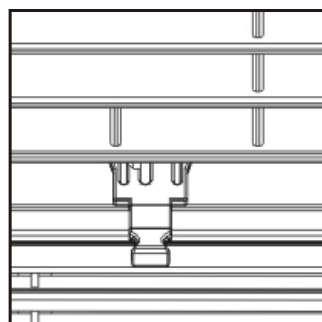
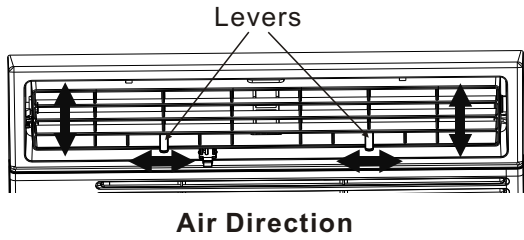

Fig. C (VENT & EXHAUST OPEN)

Air Directional Louvers



The louvers will allow you to direct the air flow UP or DOWN(only on some models) and Left or Right throughout the room as needed. Pivot horizontal louvers until they are in the preferred direction.

Move the Levers from side to side until the desired LEFT/RIGHT direction is obtained.

INSTALLATION INSTRUCTIONS

Your air conditioner is designed to be installed in standard double hung windows with opening widths of 23 to 36 inches(58.4cm to 91.4cm) (See Fig.D).

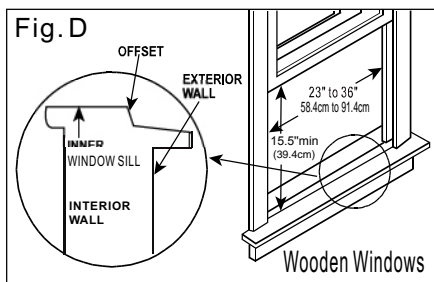

Lower sash must open sufficiently to allow a clear vertical opening of following size (see Table 1). Side louvers and the rear of the AC must have clear air space to allow enough airflow through the condenser, for heat removal. The rear of the unit must be outdoors, not inside a building or garage.

Model	5000~8000Btu/h	10000~12000Btu/h
Size	14"(35.6cm)	15-1/2"(39.4cm)

Table 1

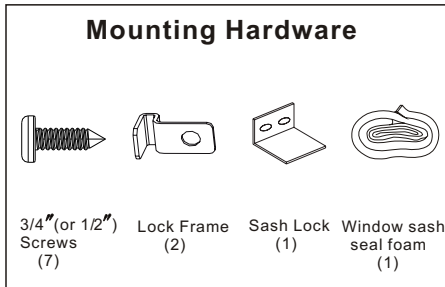

NOTE: Save **Carton** and these **Installation Instructions** for future reference. The carton is the best way to store unit during winter or when not in use.

TOOLS NEEDED:

- Phillips Screw Driver
- Drill (If pilot holes are needed)

CAUTION: When handling unit, be careful to avoid cuts from sharp metal edges and aluminum fins on front and rear coils.



NOTE: The top rail hardware and the following Fig.E, Fig.F and Fig.G are not applicable to units **more than 10000Btu/h**.

Before installing unit, the top rail must be attached on the unit (For <10000Btu/h models only).

Tool Needed: Phillips Screwdriver

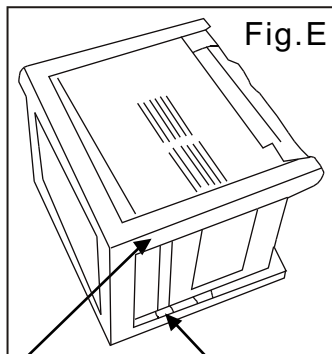

Packaging Top Rail

A: Remove the air conditioner from the carton and place on a flat surface.

B: Remove top rail from the rear of the packaging material as shown in Fig. E.

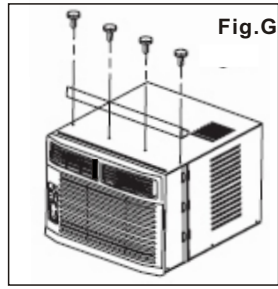
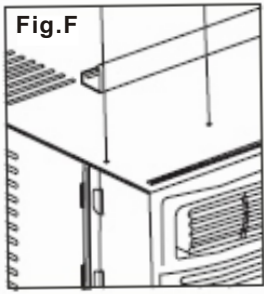

C: Align the hole in the top rail with those in the top of the unit as shown in Fig.F

D: Secure the top rail to the unit with the 3/8" Screws as shown in Fig.G.

NOTE: For safety reasons, all four(4) screws **MUST** be securely fastened.

HOW TO INSTALL

NOTE: Top rail and Sliding Panels at each side are offset to provide the proper pitch to the rear of (5/16"). This is necessary for proper condensed water utilization and drainage. If you are not using the Side Panels for any reason, this pitch to the rear must be maintained by other means.

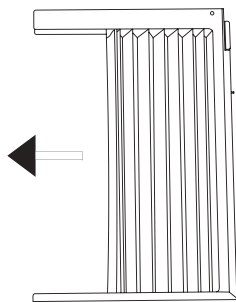

Fig.1

1 Place unit on floor, a bench or a table. There is a Left and Right side Filler Panels- be sure to use the proper panel for each side. When installed, the flange for securing the panel in place to the window sill will be facing into the room.

A. Hold the side Panel in one hand and gently pull back the center to free the open end. See Fig.1.

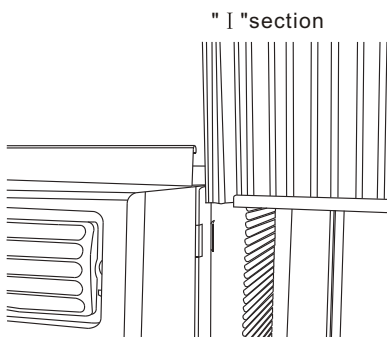

Fig.2

B. Slide the free end "I" section of the panel directly into the cabinet as shown in Fig. 2. Slide the panel down. Be sure to leave enough space to slip the top and bottom of the frame into the rails on the cabinet.

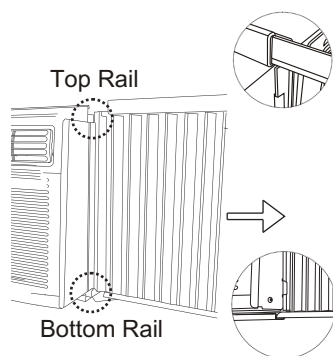

Fig.3

C. Once the panel has been installed on the side of the cabinet, make sure it sits securely inside the frame channel by making slight adjustments. Slide the top and bottom ends of the frame into the top and bottom rails of the cabinet. Fig.3.

D. Slide the panel all the way in and repeat on the other side.

NOTE: If storm window blocks AC, see Fig. 10.

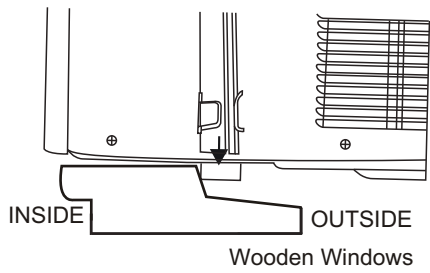

Fig.4

2 Keep a firm grip on the air conditioner, carefully place the unit into the window opening so the bottom of the air conditioner frame is against the window sill (Fig.4). Carefully close the window behind the top rail of the unit.

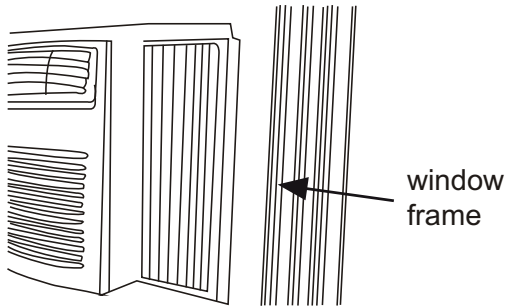

Fig.5

3 Extend the side panels out against the window frame (Fig.5).

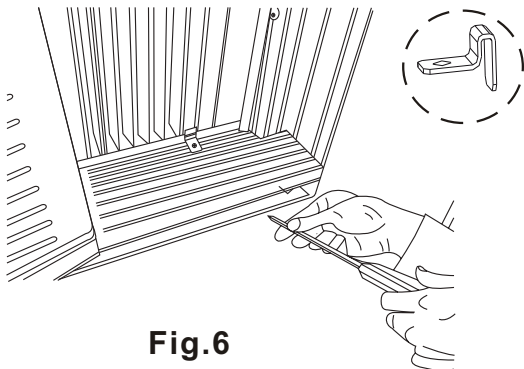

Fig.6

4 Place the frame lock between the frame extensions and the window sill as shown(Fig.6). Drive 3/4" (19mm) or 1/2" (12.7mm) locking screws through the frame lock and into the sill .

NOTE: To prevent window sill from splitting, drill 1/8" (3mm) pilot holes before driving screws.

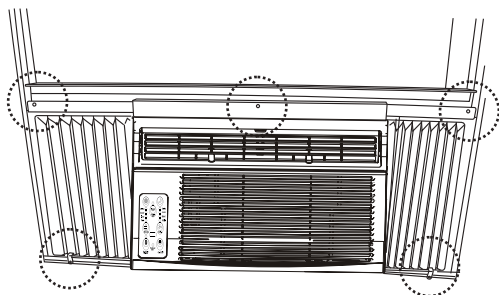

Fig.7

5 Drive 3/4" (19mm) or 1/2" (12.7mm) locking screws through frame holes into window sash (Fig.7).



Fig.8

6 To secure lower sash in place, attach right angle sash lock with 3/4" (19mm) or 1/2" (12.7mm) screw as shown(Fig.8).

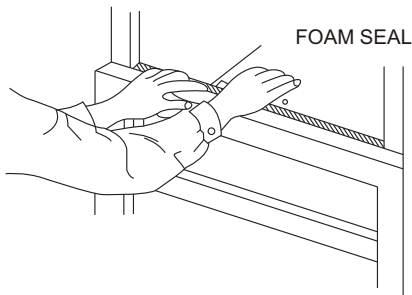

Fig.9

7 Cut Window sash seal foam and insert it in the space between the upper and lower sashes (Fig.9).

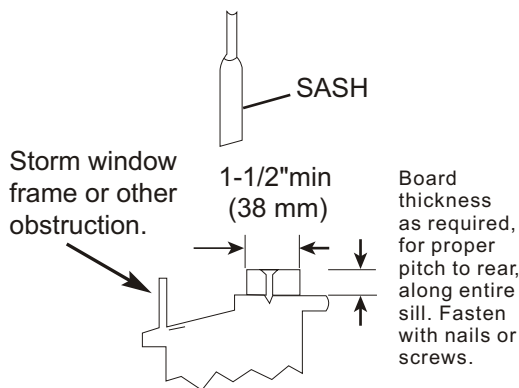

Fig.10

If AC is Blocked by Storm Window

Add wood as shown in Fig.10, or remove storm window before air conditioner is installed.

If Storm Window Frame must remain, be sure the drain holes or slots are not caulked or painted shut. Accumulated Rain Water or Condensation must be allowed to drain out.

Removing AC From Window

- ◆ Turn AC off, and disconnect power cord.
- ◆ Remove sash seal from between windows, and unscrew safety sash lock.
- ◆ Remove screws installed through frame and frame-lock.
- ◆ Close (slide) side panels into frame.
- ◆ Keeping a firm grip on air conditioner, raise sash and carefully remove.
- ◆ Be carefully not to spill any remaining water while lifting unit from window. Store parts WITH air conditioner.

NOTE: After installing, make sure the air conditioner is tilted 3~4° to the outside to allow water drainage and perfect cooling efficiency.

CLEANING AND MAINTENANCE

CAUTION

Clean your air conditioner occasionally to keep it looking new. **Be sure to unplug the unit before cleaning to prevent shock or fire hazards.**

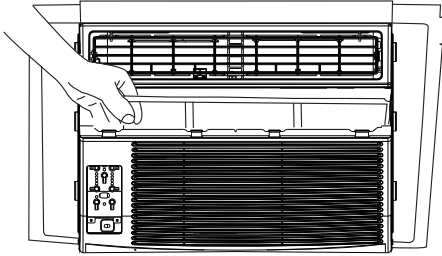

Air Filter Cleaning

The air filter should be checked at least once a month to see if cleaning is necessary. Trapped particles in the filter can build up and cause an accumulation of frost on the cooling coils.

- Push the vent handle to the Vent Closed position (where applicable).
- Open the front panel.
- Grasp the filter by the center and pull up and out.
- Wash the filter using liquid dishwashing detergent and warm water. Rinse filter thoroughly.
- Gently shake excess water from the filter. Be sure the filter is thoroughly dry before replacing.
- Or, instead of washing you may vacuum the filter clean.

Note: Never use hot water over 40°C(104°F) to clean the air filter. Never attempt to operate the unit without the air filter.

Cabinet Cleaning

- Be sure to unplug the air conditioner to prevent shock or fire hazard. The cabinet and front may be dusted with an oil-free cloth or washed with a cloth dampened in a solution of warm water and mild liquid dishwashing detergent. Rinse thoroughly and wipe dry.
- Never use harsh cleaners, wax or polish on the cabinet front.
- Be sure to wring excess water from the cloth before wiping around the controls. Excess water in or around the controls may cause damage to the air conditioner.

Winter Storage

If you plan to store the air conditioner during the winter, remove it carefully from the window according to the installation instructions. Cover it with plastic or return it to the original carton.

TROUBLESHOOTING TIPS

Before calling for service, review this list. It may save you time and expense. This list includes common problems that may not be the result of defective workman-ship or materials in this appliance.

Troubleshooting section

Problem	Solution
Air conditioner does not start	<ul style="list-style-type: none"> - Power cord may have been disconnected from the outlet. Push plug in firmly into the outlet. - Fuse or circuit breaker may have been tripped. In this case, replace fuse with a time delay type or reset circuit breaker. - Power button may be on OFF. Press the power button to turn ON. - Current detection device (on some models only) on the power cord may have been tripped. Press the RESET button on the current detection device plug.
Air From unit does not feel cool enough	<ul style="list-style-type: none"> - If the room temperature is below 62F(17C), cooling may not begin until the temperature is higher. - Temperature sensor element may be touching the cold coil, located behind the air filter. Straighten the tube away from the coil. - The temperature may need to be set lower for the air conditioner to activate. - The compressor may have been shut off by abrupt mode changes. Wait approximately 3 minutes and listen for compressor to restart when set in COOL mode.
Air conditioner is cooling, but room is still warm and ice seems to be forming on the cooling coils behind the AC casing	<ul style="list-style-type: none"> - The outdoor temperature of below 64F (18C) may be affecting operation. To defrost the coil, set the unit to FAN ONLY - The air filter may be dirty. Clean the filter as instructed on the 'CARE AND CLEANING SECTION' of this manual. - The temperature may be set too high. Set the temperature control to a lowering setting. - Air directional louvers may be positioned improperly. Position louvers for better air distribution. - The front of the unit may be obstructed by curtains, blinds, or other foreign bodies, restricting the air distribution. Clear the area around the front of AC unit. - Cold air may be escaping the room through open doors, windows or openings. Close all open doors, windows, and other openings. - In a warm room, a just activated air conditioner may need time to remove the heat present in the room and distribute cool air.

Problem	Solution
Air conditioner turns on and off rapidly	<ul style="list-style-type: none"> - A dirty air filter may be obstructing the cool air. Clean the filter as instructed on the 'CARE AND CLEANING SECTION' of this manual. - In cases where the outside temperature may be extremely high, set the FAN speed to a higher setting to circulate the air cool air better.
Noises coming from the unit when cooling	<ul style="list-style-type: none"> - This may be the operating sound of air movement and is normal. However, if the noise seems too loud, set the FAN to a lower speed setting. - The noise may be due to window vibration. This can happen when the air conditioner is installed incorrectly. Refer to the installation instruction on page 10 or check with the person who installed the unit initially.
Water dripping INDOORS when the unit is on COOL	<ul style="list-style-type: none"> - The air conditioner may have been improperly installed. Tilt the air conditioner slightly outward to allow water to drain out. Refer to installation instructions on page 10 or check with the person who installed the unit initially.
Water dripping OUTSIDE when unit is cooling	<ul style="list-style-type: none"> - The unit may be accumulating a large quantity of moisture as it is dehumidifying a humid room. This is normal operation for excessively humid weather.
Remote control 'FOLLOW ME' mode deactivates prematurely (on some models only)	<ul style="list-style-type: none"> - Remote control may not be within range of the unit. Be sure to have the remote control within a 20 foot radius in front of the unit. - The remote control signal may be obstructed. Remove any obstructions interfering with signal.
Room is too cold	<ul style="list-style-type: none"> - The temperature setting may be too low. Increase the temperature to a more comfortable level.

NORMAL OPERATING SOUNDS

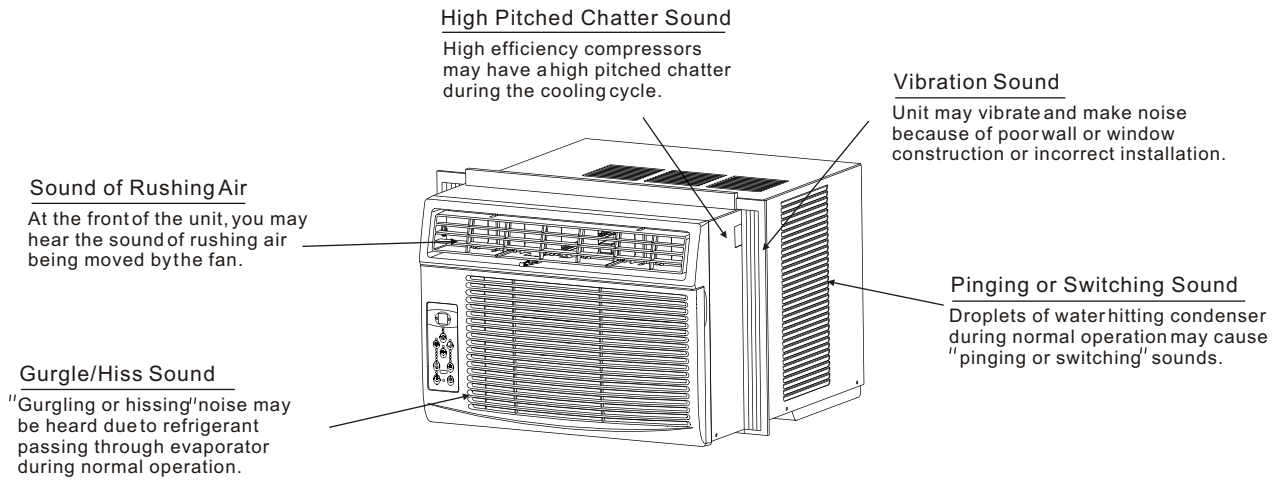

The design and specifications are subject to change without prior notice for product improvement. Consult with the sales agency or manufacturer for details.

MAGNAVOX and SMART. VERY SMART are registered trademarks of Koninklijke Philips N.V. and are used under license from Koninklijke Philips N.V.